

STL251C



Familie	Vaatwasser
Commerciële breedte	60 cm
Nishoogte	82 cm
Installatie	Volledig geïntegreerd
Deur paneel	Niet meegeleverd
Aantal korven	2
Motor	Inverter 2.0
EAN-code	8017709306922



Programma's / functies



Aantal programma's	5	Eco	Ja
Wastemperatuur	45, 50, 65, 75 °C	Mix	Ja
Krystal	Ja	Hygiene 99,9%	Yes
Full express - 60 minutes	Ja		

Opties



Delay timer optie	3-6-9 uur, i.c.m. automatisch spoelen	Extra Dry optie	Ja
-------------------	---------------------------------------	-----------------	----

Korven



Kleur korven	Grijs	Maximum afmetingen bord dat in bovenste korf kan worden geladen	25,0 cm
Kleur korfcomponenten	Grijs	Onderkorf	2 inklapbare rekken
Handgreep	Op onder- en bovenkorf	Onderkorf met anti-drup inserts	Ja
Bovenkorf	Met vaste rekken		
Glazen houder	Ja		
In hoogte verstelbare bovenkorf	3 niveaus		

Maximum afmetingen bord dat in onderste korf kan worden geladen	30,0 cm
Kleur binnenonderdelen	Blauw
Bestekmandje	Ja

Technische specificaties



Breedte product	598 mm	Maximale waterhardheid	100°fH;58°dH
Diepte product	545 mm	Droogstelsysteem	Natuurlijk condensor drogen met Dry Assist + automatische deuropeningssysteem aan het einde van de cyclus
Hoogte product	818 mm	Stoombeveiliging	Van kunststof
Bediening	Elektronisch	Materiaal kuip	RVS
Grafische weergave programma's	Symbolen	Filter	RVS
Aan/uit indicator	Ja	Verborgen verwarmingselement	Ja
Zout indicator	Indicator (lampje)	Scharnieren	Self balancing, Sliding, FLEXIFIT
Glansspoelmiddel indicator	Indicator (lampje)	Min. en max. frontaal paneelgewicht	2 - 11 kg
Indicator einde cyclus	Akoestisch signaal	Min. en max. plintheogte	50 - 215 mm
Wassysteem	Orbital	Verstelbare voetjes	7 cm, van 820 tot 890 mm
Derde sproeiarm	Enkel	Back cover	Ja
Waterontkalker	Elektronisch instelbaar	Diepte vaatwasser met open deur (mm)	1168
Overstroombeveiliging	Total Acquastop	Voetjes achterzijde vanaf de voorkant regelbaar	Ja
Watertoevoer	Enkel; koud en warm water tot 60°C - energiebesparing tot 35%	Bovenbedekking	Van kunststof



Energie-efficiëntieklasse (wascyclus)	C	Programmaduur	4:40 h:min
Energy consumption [per 100 cycles, based on the eco programme]	73 kWh	Airborne acoustical noise emissions	45 dB(A) re 1 pW
Nominale capaciteit (ps)	13	Akoestisch geluidsemissieklasse	C
Water consumption [per cycle]	8.5 litres	Energy efficiency Index (EEI)	43.8

Elektrische aansluiting

Stekker	(F;E) Schuko	Frequentie	50 Hz
----------------	--------------	-------------------	-------

Aansluitwaarde 1800 W
Stroom 10 A
Spanning 220-240 V

Type aansluiting Single-phase
Lengte voedingskabel 140 cm

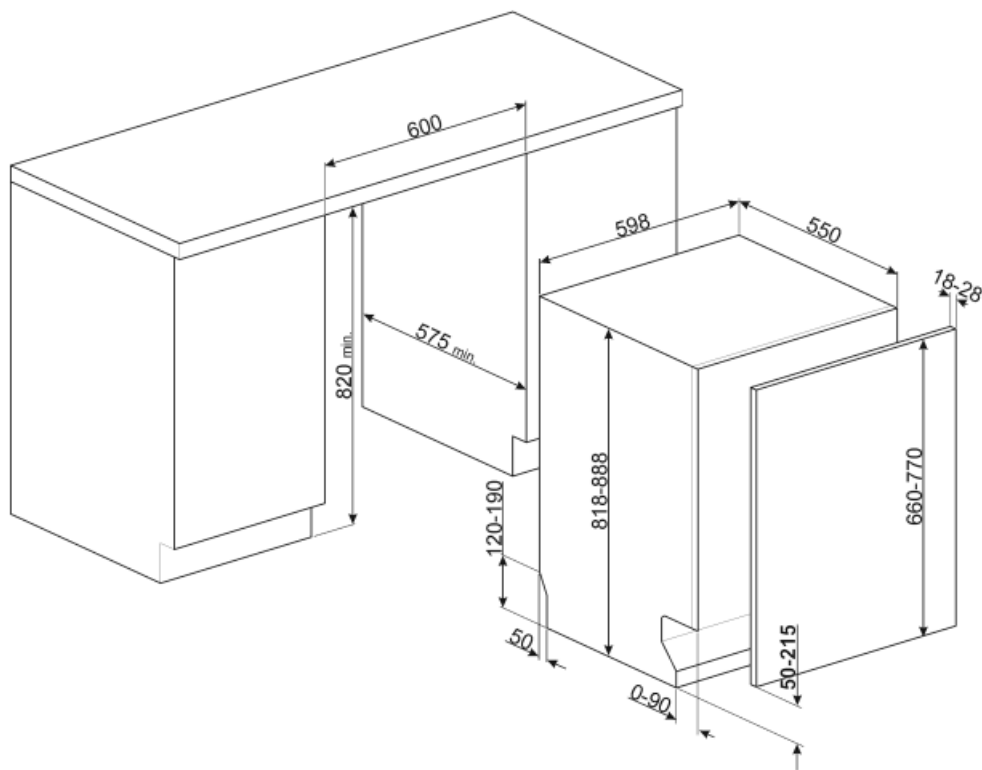

Accessoires niet inbegrepen



KITPL60N

Toekick Kit in zwarte kleur met verstelbare hoogte en diepte. Kan worden geïnstalleerd over alle volledig geïntegreerde modellen en onderbouw modellen met variabel draaipunt of flexifit-scharnieren.



KITPL60X

Toekick Kit in roestvrij staal met verstelbare hoogte en diepte. Kan worden gemonteerd over alle volledig geïntegreerde modellen en onderbouw modellen met variabel draaipunt of flexifit-scharnieren.



KITFLEXI

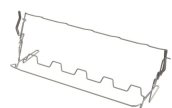

KITGH

Kit glazen houder. Deze moet op de eerste mand worden gemonteerd, maar alleen als er inklapbare rekken zijn



KIT82CX

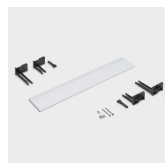

KITPL60B

















Toekick Kit in witte kleur met verstelbare hoogte en diepte. Kan worden geïnstalleerd over alle volledig geïntegreerde modellen en modellen onderbouw met variabel draaipunt of flexifit-scharnieren.



KITPLV2

Kit verlengstuk voor vaatwasser en wasmachine: lengte 2 mtr.

Symbols glossary (TT)

 To improve the drying of dishes without leaving stains.	 82 cm high
 Vertragingstimer: De uitgestelde timer kan de start van het programma tot 24 uur uitstellen.	 Energy efficiency class C
 The FlexiFit hinges allow the kitchen panel to slide over the dishwasher door, allowing a minimum kitchen plinth height of 5 cm.	 The work aimed at continuous improvement has allowed the creation of the second generation of the Inverter motor 2.0, characterised by greater efficiency and durability over time, which allows very high performance and a lower energy consumption and noise level.
 Noise Level: Excellent insulation and special devices keep noise to a minimum.	 EXTRA DRY This option adds a hot rinse cycle that ensures improved drying.
 Orbital wash system distributes water evenly throughout the 60cm dishwasher cavity, directing water with precision to ensure an excellent wash.	 Crystals: The Crystals programme is dedicated to delicate dishes such as glasses and china.
 Eco: Eco, this economic wash programme uses a low amount of water and energy in order to provide the most environmentally friendly cleaning option.	 Mix: The Mix programme is suitable for mixed crockery and everyday pots and pans, without any particular incrustation.
 13 place settings: Number of place settings.	 Total Acquastop: In addition to the partial Acquastop protection present in all Smeg dishwashers, some models have an electronic device fitted to the water intake hose, which monitors water levels in the machine, detects leaks in the hose and switches off the water supply immediately when necessary.
 System WaterSave ensures the best washing results with minimal water consumption depending on the model of dishwasher.	 Quick wash cycle for normally soiled mixed loads such as dishes and pans, even with dried-on residues. Dishes are washed and dried in 60 minutes.
 HYGIENE 99.9% High-temperature washing programme. The 75° rinse guarantees the removal of 99.9% of germs and bacteria.	