

ST273CL

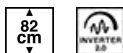

Familie	Vaatwasser
Commerciële breedte	60 cm
Nishoogte	82 cm
Installatie	Volledig geïntegreerd
Deur paneel	Niet meegeleverd
Aantal korven	2
Motor	Inverter 2.0
EAN-code	8017709306847



Programma's / functies



Aantal programma's	10+1	Auto sensor 45-65	Ja
Wastemperatuur	38, 45, 50, 55, 65, 70, 75 °C	Mix	Ja
Weken	Ja	Stil (-2dB)	Ja
Express 27'	Ja	Intensief	Ja
Krystal	Ja	Zelf reinigen	Ja
Full express - 60 minutes	Ja	Hygiene 99,9%	Yes
Eco	Ja		

Opties



Dry Assist + opties	Yes	FlexiZone ½ (halve beladingsmogelijkheid)	Ja
Delay timer optie	Tot 24 uur, i.c.m. automatisch spoelen	Optie speciale programma's	Ja

Korven



Kleur korven	Grijs	Maximum afmetingen bord dat in bovenste korf kan worden geladen	25,0 cm
Kleur korfcomponenten	Grijs		
Handgreep	Op onder- en bovenkorf		
Bovenkorf	Met 1 opvouwbaar rek		

Glazen houder	Ja	Onderkorf	2 inklapbare rekken
In hoogte verstelbare bovenkorf	3 niveaus	Onderkorf met anti-drup inserts	Ja
		Maximum afmetingen bord dat in onderste korf kan worden geladen	30,0 cm
		Kleur binnenonderdelen	Groen
		Bestekmandje	Ja

Technische specificaties



Breedte product	598 mm	Watertoevoer	Enkel; koud en warm water tot 60°C - energiebesparing tot 35%
Diepte product	545 mm	Maximale waterhardheid	100°FH;58°dH
Type display	3 cijfers	Droogstelsysteem	Natuurlijk condensor drogen met Dry Assist + automatische deuropeningssysteem aan het einde van de cyclus
Hoogte product	818 mm	Stoombeveiliging	Van kunststof
Bediening	Elektronisch	Materiaal kuip	RVS
Display	Instelling Delay timer, Programma duur indicator	Filter	RVS
Grafische weergave programma's	Symbolen	Verborgen verwarmingselement	Ja
Aan/uit indicator	Ja	Scharnieren	Zelfbalancerend met vast steunpunt
Zout indicator	Indicator (lampje)	Min. en max. frontaal paneelgewicht	2 - 9 kg
Glansspoelmiddel indicator	Indicator (lampje)	Min. en max. plinthoogte	100 - 228 mm
Indicator einde cyclus	ActiveLight	Verstelbare voetjes	7 cm, van 820 tot 890 mm
Wassysteem	Orbital	Back cover	Ja
Derde sproeiarm	Enkel	Diepte vaatwasser met open deur (mm)	1168
Waterontkalker	Elektronisch instelbaar	Voetjes achterzijde vanaf de voorkant regelbaar	Ja
Aquatest sensor	Ja	Bovenbedekking	Van kunststof
Overstroombeveiliging	Total Acquastop		



Energie-efficiëntieklasse (wascyclus)	C	Programmaduur	4:40 h:min
Energy consumption [per 100 cycles, based on the eco programme]	73 KWh	Airborne acoustical noise emissions	47 dB(A) re 1 pW
Nominale capaciteit (ps)	13	Akoestisch geluidsemissieklasse	C

Water consumption [per cycle] 8.5 litres

Energy efficiency Index (EEI) 43.8

Elektrische aansluiting

Stekker (F;E) Schuko
Aansluitwaarde 1800 W
Stroom 10 A
Spanning 220-240 V

Frequentie 50 Hz
Type aansluiting Single-phase
Lengte voedingskabel 140 cm

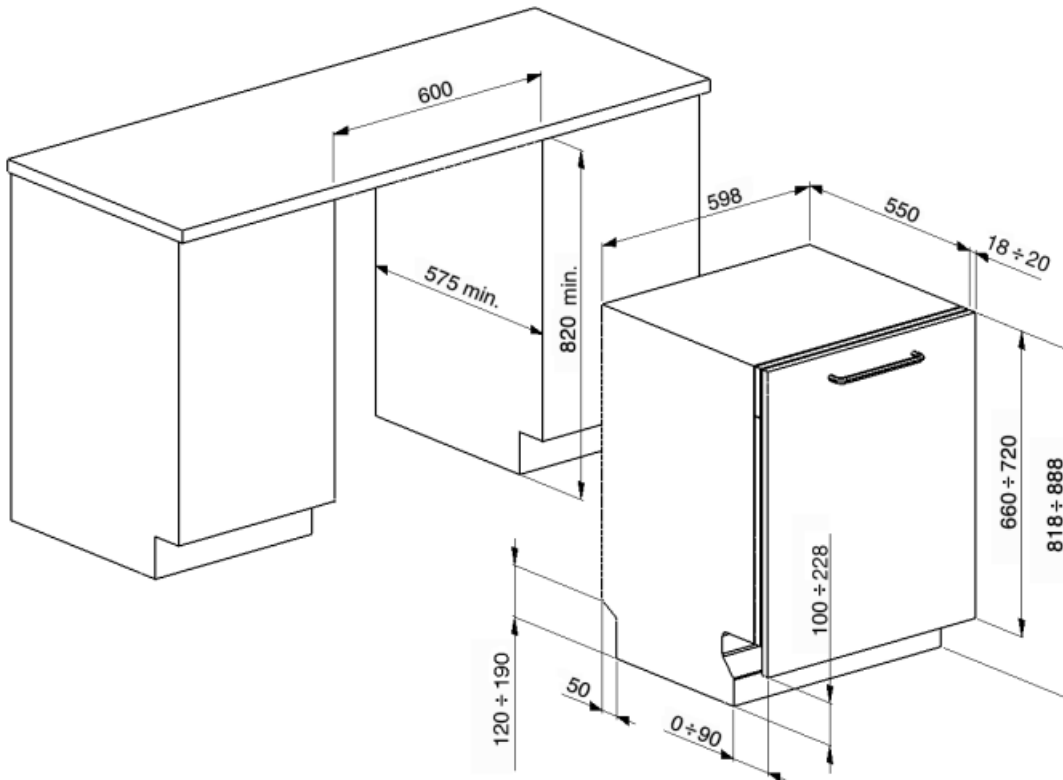

Accessoires niet inbegrepen

KITPL60FABB

Kit in witte kleur in hoogte verstelbaar. Kan over alle volledig geïntegreerde en onderbouwmodellen met vast steunpunt worden gemonteerd. Kan ook worden geïnstalleerd op de modellen met variabel draaipunt of flexifit-scharnieren.



KIT82CX



KITPLV2

Kit verlengstuk voor vaatwasser en wasmachine: lengte 2 mtr.



KITPL60FABX

Kit in roestvrij staal in hoogte verstelbaar. Kan over alle volledig geïntegreerde en onderbouwmodellen met vast steunpunt worden gemonteerd. Kan ook worden geïnstalleerd op de modellen met variabel draaipunt of flexifit-scharnieren.

KITPL60FABN

Kit in zwarte kleur in hoogte verstelbaar. Kan over alle volledig geïntegreerde en onderbouwmodellen met vast steunpunt worden gemonteerd. Kan ook worden geïnstalleerd op de modellen met variabel draaipunt of flexifit-scharnieren.







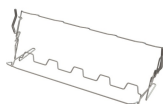

















KITGH

Kit glazen houder. Deze moet op de eerste mand worden gemonteerd, maar alleen als er inklapbare rekken zijn



Symbols glossary (TT)

	Activelight is een led die een rode stip projecteert op de vloer onder de vaatwasser als het apparaat in gebruik is		Aquatest meet de helderheid van het water tijdens een automatisch programma en zorgt automatisch voor een minimaal verbruik van water en energie
	To improve the drying of dishes without leaving stains.		82 cm high
	Vertragingstimer: De uitgestelde timer kan de start van het programma tot 24 uur uitstellen.		Energy efficiency class C
	The Dry Assist + option, in addition to saving energy, ensures perfect drying of the dishes by opening the door automatically at the end of the washing cycle.		FlexiZone: The ½ load flexizone allows you to wash a reduced load saving energy, water and time and there are no restrictions on where the items are placed.
	The work aimed at continuous improvement has allowed the creation of the second generation of the Inverter motor 2.0, characterised by greater efficiency and durability over time, which allows very high performance and a lower energy consumption and noise level.		Noise Level: Excellent insulation and special devices keep noise to a minimum.
	Orbital wash system distributes water evenly throughout the 60cm dishwasher cavity, directing water with precision to ensure an excellent wash.		Auto 45°- 65°: The auto programme regulates the length of a cycle depending on the need for a pre-wash and the number of rinses required.
	Crystals: The Crystals programme is dedicated to delicate dishes such as glasses and china.		Eco: Eco, this economic wash programme uses a low amount of water and energy in order to provide the most environmentally friendly cleaning option.
	Mix: The Mix programme is suitable for mixed crockery and everyday pots and pans, without any particular incrustation.		Soak programme: The soak programme provides a rinse to prevent dirt from drying.
	Express 27': The Express 27' programme is a quick wash cycle, at low temperatures, for lightly soiled dishes.		Ultraclean: The Ultraclean option performs a final rinse at a high temperature of 70°C eliminating virtually all bacteria.
	13 place settings: Number of place settings.		Total Acquastop: In addition to the partial Acquastop protection present in all Smeg dishwashers, some models have an electronic device fitted to the water intake hose, which monitors water levels in the machine, detects leaks in the hose and switches off the water supply immediately when necessary.
	System WaterSave ensures the best washing results with minimal water consumption depending on the model of dishwasher.		Quick wash cycle for normally soiled mixed loads such as dishes and pans, even with dried-on residues. Dishes are washed and dried in 60 minutes.



Dishwasher cleaning cycle. The cycle should be started with the machine empty, without dishes. It is recommended to run the program every 2-3 months, using special dishwasher detergents.



Allows you to enable additional programs when selected together with any wash cycle. After having selected the required wash cycle, press the button (



SILENT: Wash cycle suitable for normally soiled dishes, even with dried-on residues. Ensures maximum noise reduction and is therefore ideal if you wish to run it during the night.



HYGIENE 99.9% High-temperature washing programme. The 75° rinse guarantees the removal of 99.9% of germs and bacteria.