

## PL292DX



Familie	Vaatwasser
Commerciële breedte	60 cm
Nishoogte	82 cm
Installatie	Half geïntegreerd
Deur paneel	Niet meegeleverd
Aantal korven	2
Motor	Inverter 2.0
EAN-code	8017709307097



## Programma's / functies



Aantal programma's	5	Mix	Ja
Wastemperatuur	50, 65, 70 °C	Intensief	Ja
Weken	Ja	Dagelijks ½ lading	Ja
Eco	Ja		

## Opties



Delay timer optie	3-6-9 uur, i.c.m. automatisch spoelen	Extra Dry optie	Ja
-------------------	---------------------------------------	-----------------	----

## Korven



Kleur korven	Grijs	Maximum afmetingen bord dat in bovenste korf kan worden geladen	25,0 cm
Kleur korfcomponenten	Grijs	Onderkorf	2 inklapbare rekken
Handgreep	Op onder- en bovenkorf	Onderkorf met anti-drup inserts	Ja
Bovenkorf	Met vaste rekken	Maximum afmetingen bord dat in onderste korf kan worden geladen	30,0 cm
Glazen houder	Ja		
In hoogte verstelbare bovenkorf	3 niveaus		

Kleur binnenonderdelen	Groen
Bestekmandje	Ja

## Technische specificaties



Breedte product	598 mm
Diepte product	570 mm
Hoogte product	818 mm
Bediening	Elektronisch
Grafische weergave programma's	Symbolen
Aan/uit indicator	Ja
Zout indicator	Indicator (lampje)
Glansspoelmiddel indicator	Indicator (lampje)
Indicator einde cyclus	Akoestisch signaal
Wassysteem	Standaard
Derde sproeiarm	Enkel
Waterontkalker	Elektronisch instelbaar
Overstroombeveiliging	Total Acquastop

Watertoevoer	Enkel; koud en warm water tot 60°C - energiebesparing tot 35%
Maximale waterhardheid	100°fH;58°dH
Droogstelsysteem	Natuurlijk condensor drogen met Dry Assist + automatische deuropeningssysteem aan het einde van de cyclus
Stoombeveiliging	Van kunststof
Materiaal kuip	RVS
Filter	RVS
Verborgen verwarmingselement	Ja
Scharnieren	Zelfbalancerend met vast steunpunt
Min. en max plinthoogte	100 - 215 mm
Verstelbare voetjes	7 cm, van 820 tot 890 mm
Diepte vaatwasser met open deur (mm)	1146
Voetjes achterzijde vanaf de voorkant regelbaar	Ja
Bovenbedekking	Van kunststof

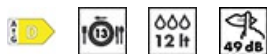

Energie-efficiëntieklasse (wascyclus)	D
Energy consumption [per 100 cycles, based on the eco programme]	84 kWh
Nominale capaciteit (ps)	13
Water consumption [per cycle]	12.0 litres

Programmaduur	4:10 h:min
Airborne acoustical noise emissions	49 dB(A) re 1 pW
Akoestisch geluidsemissieklasse	C
Energy efficiency Index (EEI)	49.9

## Elektrische aansluiting

Stekker	(F;E) Schuko	Frequentie	50 Hz
Aansluitwaarde	1800 W	Type aansluiting	Single-phase
Stroom	10 A	Lengte voedingskabel	140 cm
Spanning	220-240 V		

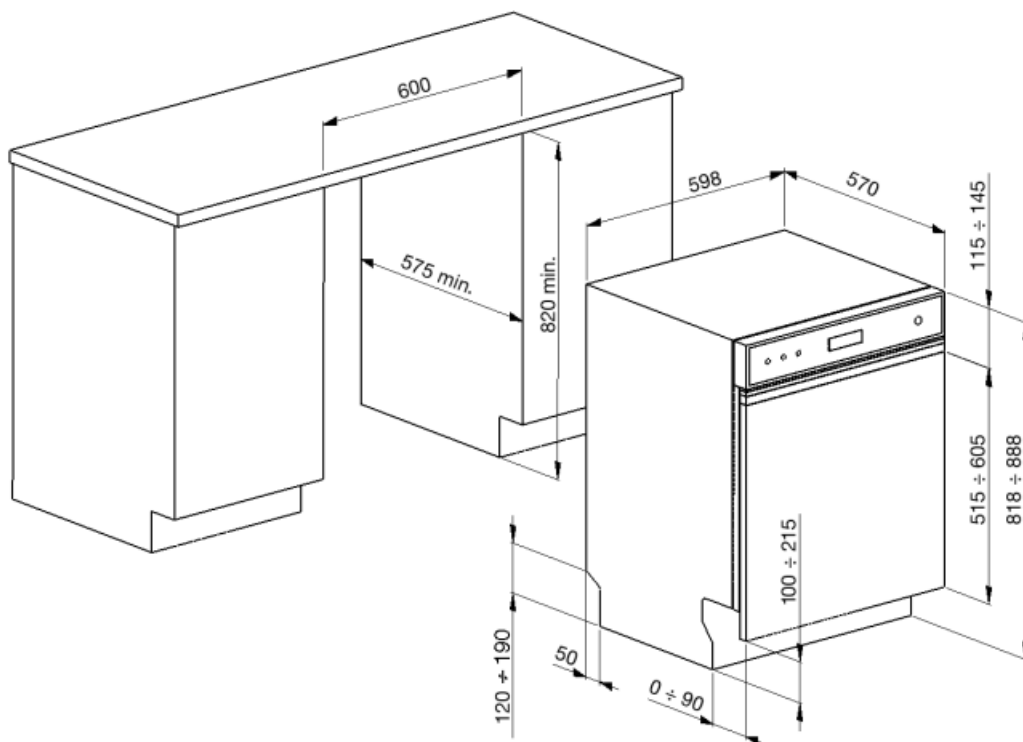

## Accessoires niet inbegrepen

### KITPL60FABB

Kit in witte kleur in hoogte verstelbaar. Kan over alle volledig geïntegreerde en onderbouwmodellen met vast steunpunt worden gemonteerd. Kan ook worden geïnstalleerd op de modellen met variabel draaipunt of flexifit-scharnieren.



### KITPL60FABN

Kit in zwarte kleur in hoogte verstelbaar. Kan over alle volledig geïntegreerde en onderbouwmodellen met vast steunpunt worden gemonteerd. Kan ook worden geïnstalleerd op de modellen met variabel draaipunt of flexifit-scharnieren.



### KITGH

Kit glazen houder. Deze moet op de eerste mand worden gemonteerd, maar alleen als er inklapbare rekken zijn

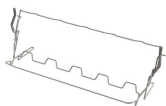

### KITPL60FABX

Kit in roestvrij staal in hoogte verstelbaar. Kan over alle volledig geïntegreerde en onderbouwmodellen met vast steunpunt worden gemonteerd. Kan ook worden geïnstalleerd op de modellen met variabel draaipunt of flexifit-scharnieren.

### KITPLV2

Kit verlengstuk voor vaatwasser en wasmachine: lengte 2 mtr.



## Alternative products

---

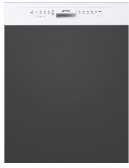















**PL292DB**



**PL292DN**

## Symbols glossary (TT)

 <p>To improve the drying of dishes without leaving stains.</p>	 <p>82 cm high</p>
 <p>Vertragingstimer: De uitgestelde timer kan de start van het programma tot 24 uur uitstellen.</p>	 <p>Energy efficiency class D</p>
 <p>The work aimed at continuous improvement has allowed the creation of the second generation of the Inverter motor 2.0, characterised by greater efficiency and durability over time, which allows very high performance and a lower energy consumption and noise level.</p>	 <p>Noise Level: Excellent insulation and special devices keep noise to a minimum.</p>
 <p>EXTRA DRY This option adds a hot rinse cycle that ensures improved drying.</p>	 <p>1/2 load: This program is designed for washing dishes not heavily soiled with partial load of the dishwasher.</p>
 <p>Eco: Eco, this economic wash programme uses a low amount of water and energy in order to provide the most environmentally friendly cleaning option.</p>	 <p>Mix: The Mix programme is suitable for mixed crockery and everyday pots and pans, without any particular incrustation.</p>
 <p>Soak programme: The soak programme provides a rinse to prevent dirt from drying.</p>	 <p>Ultraclean: The Ultraclean option performs a final rinse at a high temperature of 70°C eliminating virtually all bacteria.</p>
 <p>13 place settings: Number of place settings.</p>	 <p>Total Acquastop: In addition to the partial Acquastop protection present in all Smeg dishwashers, some models have an electronic device fitted to the water intake hose, which monitors water levels in the machine, detects leaks in the hose and switches off the water supply immediately when necessary.</p>
 <p>System WaterSave ensures the best washing results with minimal water consumption depending on the model of dishwasher.</p>	