

## LVFABCR3



Familie	Vaatwasser
Commerciële breedte	60 cm
Nishoogte	85 cm
Installatie	Vrijstaand
Aantal korven	3, FlexiDuo
Motor	Inverter 2.0
EAN-code	8017709305109



## Programma's / functies



Aantal programma's	10+1	Auto sensor 45-65	Ja
Wastemperatuur	38, 45, 50, 55, 65, 70, 75 °C	Mix	Ja
Weken	Ja	Stil (-2dB)	Ja
Express 27'	Ja	Intensief	Ja
Krystal	Ja	Zelf reinigen	Ja
Full express - 60 minutes	Ja	Hygiene 99,9%	Yes
Eco	Ja		

## Opties



Dry Assist + opties	Yes	FlexiZone ½ (halve beladingsmogelijkheid)	Ja
Delay timer optie	Tot 24 uur, i.c.m. automatisch spoelen	Optie speciale programma's	Ja

## Korven



Kleur korven	Grijs	Bovenmand met EasyGlide System:	Ja
Kleur korfcomponenten	Grijs		

<b>Handgreep</b>	Van kunststof met roestvrijstalen inzet op boven- en onderrek	<b>Maximum afmetingen bord dat in bovenste korf kan worden geladen</b>	19,0 cm
<b>Bovenkorf</b>	Met 3 opvouwbare rekken	<b>Onderkorf</b>	Met 4 opvouwbare rekken
<b>Glazen houder</b>	Ja	<b>Onderkorf met anti-drup inserts</b>	Ja
<b>In hoogte verstelbare bovenkorf</b>	3 niveaus	<b>Maximum afmetingen bord dat in onderste korf kan worden geladen</b>	30,0 cm
		<b>Kleur binnenonderdelen</b>	Grijs FlexiDuo, Grijs Planetarium, Cup shelves, Handle, Anti drop inserts, Cutlery basket: same colour of Dishwasher

## Technische specificaties



<b>Breedte product</b>	598 mm	<b>Aquatest sensor</b>	Ja
<b>Diepte product</b>	627 mm	<b>Overstroombeveiliging</b>	Total Acquastop
<b>Type display</b>	1 cijfer	<b>Watertoevoer</b>	Enkel; koud en warm water tot 60°C - energiebesparing tot 35%
<b>Hoogte product</b>	885 mm	<b>Maximale waterhardheid</b>	100°FH;58°dH
<b>Bediening</b>	Elektronisch	<b>Droogstelsysteem</b>	Natuurlijk condensor drogen met Dry Assist + automatische deuropeningssysteem aan het einde van de cyclus
<b>Display</b>	Instelling Delay timer	<b>Materiaal kuip</b>	RVS
<b>Grafische weergave programma's</b>	Symbolen	<b>Filter</b>	RVS
<b>Aan/uit indicator</b>	Ja	<b>Verborgen verwarmingselement</b>	Ja
<b>Zout indicator</b>	Indicator (lampje)	<b>Scharnieren</b>	Zelfbalancerend met vast steunpunt
<b>Glansspoelmiddel indicator</b>	Indicator (lampje)	<b>Verstelbare voetjes</b>	Alleen voor niveau aanpassing
<b>Indicator einde cyclus</b>	Akoestisch signaal	<b>Back cover</b>	Ja
<b>Wassysteem</b>	Planetarium	<b>Diepte vaatwasser met open deur (mm)</b>	1171
<b>Derde sproeiarm</b>	Enkel	<b>Bovenbedekking</b>	Van kunststof
<b>Waterontkalker</b>	Elektronisch instelbaar		

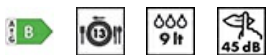

<b>Energie-efficiëntieklasse B (wascyclus)</b>	<b>Programmaduur</b>	4:25 h:min
	<b>Airborne acoustical noise emissions</b>	45 dB(A) re 1 pW

Energy consumption 63 kWh  
[per 100 cycles, based  
on the eco programme]

Akoestisch  
geluidsemis­sie­klasse C  
Energy efficiency Index  
(EEI) 37,9

Nominale capaciteit (ps) 13  
Water consumption [per  
cycle] 9,0 litres

## Elektrische aansluiting

Stekker (F;E) Schuko  
Aansluitwaarde 1800 W  
Stroom 10 A  
Spanning 220-240 V

Frequentie 50 Hz  
Type aansluiting Single-phase  
Lengte voedingskabel 140 cm

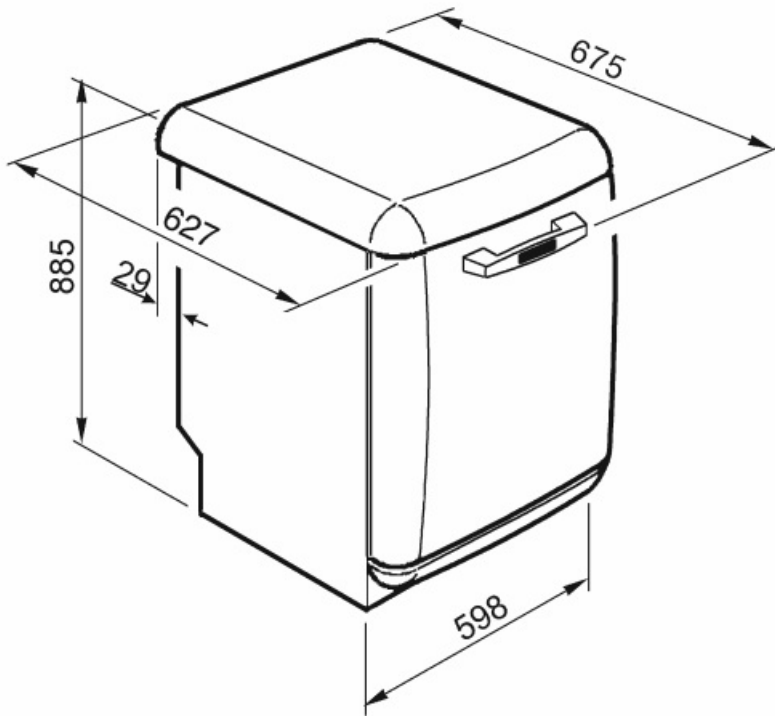

## Accessoires niet inbegrepen

---

### KITINC

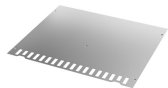

### KITGH

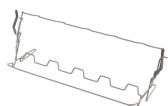

Kit glazen houder. Deze moet op de eerste mand worden gemonteerd, maar alleen als er inklapbare rekken zijn

### KITPLV2



Kit verlengstuk voor vaatwasser en wasmachine: lengte 2 mtr.























## Alternative products

---



LVFABBL3

## Symbols glossary (TT)

	Aquatest meet de helderheid van het water tijdens een automatisch programma en zorgt automatisch voor een minimaal verbruik van water en energie		To improve the drying of dishes without leaving stains.
	Vertragingstimer: De uitgestelde timer kan de start van het programma tot 24 uur uitstellen.		Energy efficiency class B
	The Dry Assist + option, in addition to saving energy, ensures perfect drying of the dishes by opening the door automatically at the end of the washing cycle.		EasyGlide: handig EasyGlide-systeem voor eenvoudig uitladen van het apparaat en dat maximale flexibiliteit van het laden van de machine mogelijk maakt
	FlexiDuo: The FlexiDuo 3rd cutlery basket allows you to arrange cutlery or small cups, ladles, or bulky utensils however you like: it consists of two separate and moveable modules.		FlexiZone: The ½ load flexizone allows you to wash a reduced load saving energy, water and time and there are no restrictions on where the items are placed.
	The work aimed at continuous improvement has allowed the creation of the second generation of the Inverter motor 2.0, characterised by greater efficiency and durability over time, which allows very high performance and a lower energy consumption and noise level.		Noise Level: Excellent insulation and special devices keep noise to a minimum.
	The Planetarium washing system, with high rotations per minute, guarantees complete coverage of the tank, thanks to the simultaneous rotation of base and sprayers, and excellent washing results.		Auto 45°- 65°: The auto programme regulates the length of a cycle depending on the need for a pre-wash and the number of rinses required.
	Crystals: The Crystals programme is dedicated to delicate dishes such as glasses and china.		Eco: Eco, this economic wash programme uses a low amount of water and energy in order to provide the most environmentally friendly cleaning option.
	Mix: The Mix programme is suitable for mixed crockery and everyday pots and pans, without any particular incrustation.		Soak programme: The soak programme provides a rinse to prevent dirt from drying.
	Express 27': The Express 27' programme is a quick wash cycle, at low temperatures, for lightly soiled dishes.		Ultraclean: The Ultraclean option performs a final rinse at a high temperature of 70°C eliminating virtually all bacteria.
	13 place settings: Number of place settings.		Total Acquastop: In addition to the partial Acquastop protection present in all Smeg dishwashers, some models have an electronic device fitted to the water intake hose, which monitors water levels in the machine, detects leaks in the hose and switches off the water supply immediately when necessary.
	System WaterSave ensures the best washing results with minimal water consumption depending on the model of dishwasher.		Quick wash cycle for normally soiled mixed loads such as dishes and pans, even with dried-on residues. Dishes are washed and dried in 60 minutes.



Dishwasher cleaning cycle. The cycle should be started with the machine empty, without dishes. It is recommended to run the program every 2-3 months, using special dishwasher detergents.



Allows you to enable additional programs when selected together with any wash cycle. After having selected the required wash cycle, press the button (



**SILENT:** Wash cycle suitable for normally soiled dishes, even with dried-on residues. Ensures maximum noise reduction and is therefore ideal if you wish to run it during the night.



**HYGIENE 99.9%** High-temperature washing programme. The 75° rinse guarantees the removal of 99.9% of germs and bacteria.