

STL352C



Familie	Vaatwasser
Commerciële breedte	60 cm
Nishoogte	82 cm
Installatie	Volledig geïntegreerd
Deur paneel	Niet meegeleverd
Aantal korven	3, Flexi
Motor	Inverter 2.0
EAN-code	8017709306991



Programma's / functies



Aantal programma's	10+1	Mix	Ja
Wastemperatuur	38, 45, 50, 55, 65, 70, 75 °C	Stil (-2dB)	Ja
Weken	Ja	Intensief	Ja
Express 27'	Ja	Zelf reinigen	Ja
Krystal	Ja	Hygiene 99,9%	Yes
Full express - 60 minutes	Ja	Delicate vaat	Ja
Eco	Ja		

Opties



Dry Assist + opties	Yes	FlexiZone ½ (halve beladingsmogelijkheid)	Ja
Delay timer optie	Tot 24 uur, i.c.m. automatisch spoelen	Optie speciale programma's	Ja

Korven



Kleur korven	Grijs	Maximum afmetingen bord dat in bovenste korf kan worden geladen	19,0 cm
Kleur korfcomponenten	Grijs		
Handgreep	Op onder- en bovenkorf		
Bovenkorf	Met vaste rekken		
Glazen houder	Ja		

In hoogte verstelbare bovenkorf	3 niveaus	Onderkorf	2 inklapbare rekken
		Onderkorf met anti-drup inserts	Ja
		Maximum afmetingen bord dat in onderste korf kan worden geladen	30,0 cm
		Kleur binnenonderdelen	Blauw

Technische specificaties



Breedte product	598 mm	Maximale waterhardheid	100°fH;58°dH
Diepte product	545 mm	Droogsysteem	Natuurlijk condensor drogen met Dry Assist + automatische deuropeningssysteem aan het einde van de cyclus
Type display	3 cijfers	Stoombeveiliging	Van kunststof
Hoogte product	818 mm	Materiaal kuip	RVS
Bediening	Elektronisch	Filter	RVS
Display	Instelling Delay timer, Programma duur indicator	Verborgen verwarmingselement	Ja
Grafische weergave programma's	Symbolen	Scharnieren	Self balancing, Sliding, FLEXIFIT
Zout indicator	Indicator (lampje)	Min. en max. frontaal paneelgewicht	2,5 - 11 kg
Glanspoelmiddel indicator	Indicator (lampje)	Min. en max plinthoogte	50 - 215 mm
Indicator einde cyclus	Akoestisch signaal	Verstelbare voetjes	7 cm, van 820 tot 890 mm
Wassysteem	Orbital	Extra pakkingen	Ja, met roestvrijstalen plaat
Derde sproeiarm	Enkel	Back cover	Ja
Waterontkalker	Elektronisch instelbaar	Diepte vaatwasser met open deur (mm)	1168
Overstroombeveiliging	Total Acquastop	Voetjes achterzijde vanaf de voorkant regelbaar	Ja
Watertoevoer	Enkel; koud en warm water tot 60°C - energiebesparing tot 35%	Bovenbedekking	Van kunststof

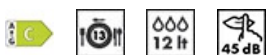

Energie-efficiëntieklasse (wascyclus)	C	Programmaduur	4:10 h:min
Energy consumption [per 100 cycles, based on the eco programme]	73 KWh	Airborne acoustical noise emissions	45 dB(A) re 1 pW
Nominale capaciteit (ps)	13	Akoestisch geluidsemissieklasse	C
Water consumption [per cycle]	12,0 litres	Energy efficiency Index (EEI)	43,8

Elektrische aansluiting

Stekker	(F;E) Schuko	Frequentie	50 Hz
Aansluitwaarde	1800 W	Type aansluiting	Single-phase
Stroom	10 A	Lengte voedingskabel	140 cm
Spanning	220-240 V		

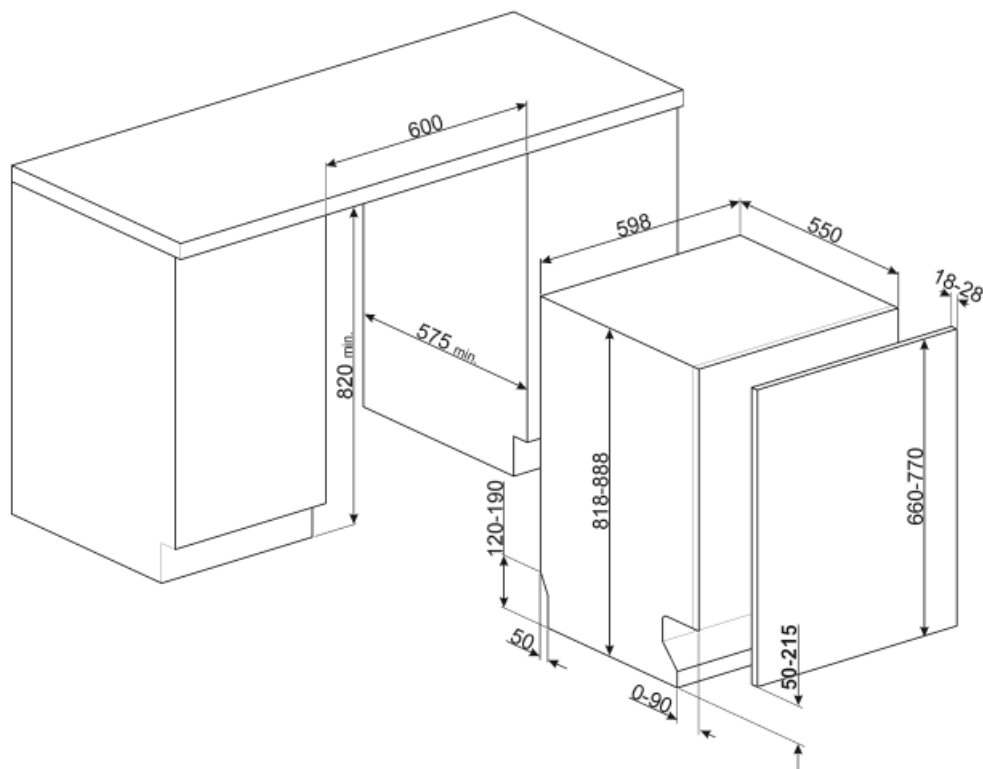

Accessoires niet inbegrepen



KITPL60N

Toekick Kit in zwarte kleur met verstelbare hoogte en diepte. Kan worden geïnstalleerd over alle volledig geïntegreerde modellen en onderbouw modellen met variabel draaipunt of flexifit-scharnieren.



KITPL60X

Toekick Kit in roestvrij staal met verstelbare hoogte en diepte. Kan worden gemonteerd over alle volledig geïntegreerde modellen en onderbouw modellen met variabel draaipunt of flexifit-scharnieren.



KITFLEXI

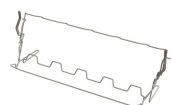

KITGH

Kit glazen houder. Deze moet op de eerste mand worden gemonteerd, maar alleen als er inklapbare rekken zijn



KIT82CX

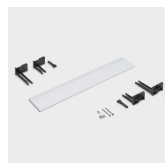

KITPL60B

Toekick Kit in witte kleur met verstelbare hoogte en diepte. Kan worden geïnstalleerd over alle volledig geïntegreerde modellen en modellen onderbouw met variabel draaipunt of flexifit-scharnieren.



























KITPLV2

Kit verlengstuk voor vaatwasser en wasmachine: lengte 2 mtr.



KIT82CN

Symbols glossary (TT)

 To improve the drying of dishes without leaving stains.	 82 cm high
 Vertragingstimer: De uitgestelde timer kan de start van het programma tot 24 uur uitstellen.	 Energy efficiency class C
 The Dry Assist + option, in addition to saving energy, ensures perfect drying of the dishes by opening the door automatically at the end of the washing cycle.	 The FlexiFit hinges allow the kitchen panel to slide over the dishwasher door, allowing a minimum kitchen plinth height of 5 cm.
 FlexiZone: The ½ load flexizone allows you to wash a reduced load saving energy, water and time and there are no restrictions on where the items are placed.	 The work aimed at continuous improvement has allowed the creation of the second generation of the Inverter motor 2.0, characterised by greater efficiency and durability over time, which allows very high performance and a lower energy consumption and noise level.
 Noise Level: Excellent insulation and special devices keep noise to a minimum.	 Orbital wash system distributes water evenly throughout the 60cm dishwasher cavity, directing water with precision to ensure an excellent wash.
 Crystals: The Crystals programme is dedicated to delicate dishes such as glasses and china.	 Delicate: Delicate washing program is designed for delicate dishes which are not heavily soiled.
 Eco: Eco, this economic wash programme uses a low amount of water and energy in order to provide the most environmentally friendly cleaning option.	 Mix: The Mix programme is suitable for mixed crockery and everyday pots and pans, without any particular incrustation.
 Soak programme: The soak programme provides a rinse to prevent dirt from drying.	 Express 27': The Express 27' programme is a quick wash cycle, at low temperatures, for lightly soiled dishes.
 Ultraclean: The Ultraclean option performs a final rinse at a high temperature of 70°C eliminating virtually all bacteria.	 13 place settings: Number of place settings.
 Total Acquastop: In addition to the partial Acquastop protection present in all Smeg dishwashers, some models have an electronic device fitted to the water intake hose, which monitors water levels in the machine, detects leaks in the hose and switches off the water supply immediately when necessary.	 System WaterSave ensures the best washing results with minimal water consumption depending on the model of dishwasher.
 Quick wash cycle for normally soiled mixed loads such as dishes and pans, even with dried-on residues. Dishes are washed and dried in 60 minutes.	 Dishwasher cleaning cycle. The cycle should be started with the machine empty, without dishes. It is recommended to run the program every 2-3 months, using special dishwasher detergents.
 SILENT: Wash cycle suitable for normally soiled dishes, even with dried-on residues. Ensures maximum noise reduction and is therefore ideal if you wish to run it during the night.	 Allows you to enable additional programs when selected together with any wash cycle. After having selected the required wash cycle, press the button (



HYGIENE 99.9% High-temperature washing programme. The 75° rinse guarantees the removal of 99.9% of germs and bacteria.