

SF6101TB3



Categorie	60 cm
Familie	Oven
Voeding	Elektrisch
Warmte bron	Elektrisch
Bereidingswijze	Thermogeventileerd
Reinigingssysteem	Vapor Clean
EAN-code	8017709329310



Esthetiek

Esthetiek	Linea	Type zeefdruk	Symbolen
Kleur	Zwart	Deur	Geheel glas
Design	Plat	Handgreep	Linea minimal
Materiaal	Glas	Kleur handgreep	Zwart
Type glas	Clear1	Logo	Geëts
Kleur serigrafie	Grijs		

Bediening



Naam display	CompactScreen	Aantal bedieningsknoppen	2
Display technologie	LCD	Bedieningsknoppen	Linea
Regeling bediening	Bedieningsknoppen	Kleur knoppen	Zwart

Programma's / functies

Aantal kookfuncties	10
----------------------------	----

Traditionele kookfuncties

 Statisch	 Geventileerd	 Circulaire
 Turbohitte	 ECO	 Grote vlak-grill
 Fan grill (large)	 Base	 Circulaire + bottom
 Pizza		

Overige functies

 Ontdooien op tijd	 Rijsfunctie	 Sabbath
--	---	---

Schoonmaak functie

 Vapor Clean
--

Opties



Opties	Automatische in- en uitschakeling	Overige opties	Warmhoudfunctie
tijdprogrammering	Ja	Showroom demo optie	Ja
Timer	Ja	Snelle voorverwarming	Ja
Kinderbeveiliging	Ja		

Technische specificaties



Minimum temperatuur	30 °C	Automatische uitschakeling	Ja
Maximum temperatuur	280 °C	verhittingselementen bij openen deur	
Aantal kookniveaus	5	Deur openen	Standaard opening
Type ovenrekken	Metalen zijsteunen	Deur	Temperatuur gecontroleerde deur
Kantelbare grill	Ja	Uitneembare ovendeur	Ja
Aantal lampen	1	Volledig glazen binnendeur	Ja
Soort verlichting	Halogeen	Uitneembaar glas binnendeur	Ja
Lamp vervangbaar	Ja	Totaal aantal ruiten	3
Vermogen lamp	40 W	Veiligheidsthermostaat	Ja
Automatische inschakeling verlichting bij openen deur	Ja	Koelsysteem	Mantelkoeling
Onderwarmte - vermogen	1200 W	Koelleiding	Enkel
Grill - vermogen	1800 W	Afmetingen bruikbare interne ovenruimte (hxbxd)	360x460x425 mm
Circulatie - vermogen	2000 W	Temperatuurregeling	Elektronisch

Prestaties / energielabel



Energieklasse	A+	Energy consumption in forced air convection	2.45 MJ
Netto inhoud	70 l	Energieverbruik bij verhittingsfunctie geforceerde hetelucht	0.68 kWh
Energieverbruik bij verhittingsfunctie conventioneel	1.13 kWh	Aantal ovens	1
Energy consumption in conventional mode	4.07 MJ	Energie-efficiëntie-index	81 %

Meegeleverde accessoires

Ovenrooster met stop	1	Vangschaal (40 mm)	1
Inzetrooster	1		

Elektrische aansluiting

Spanning	220-240 V	Frequentie	50/60 Hz
Stroom	13 A	Lengte voedingskabel	115 cm
Nominale aansluitwaarde	3000 W		

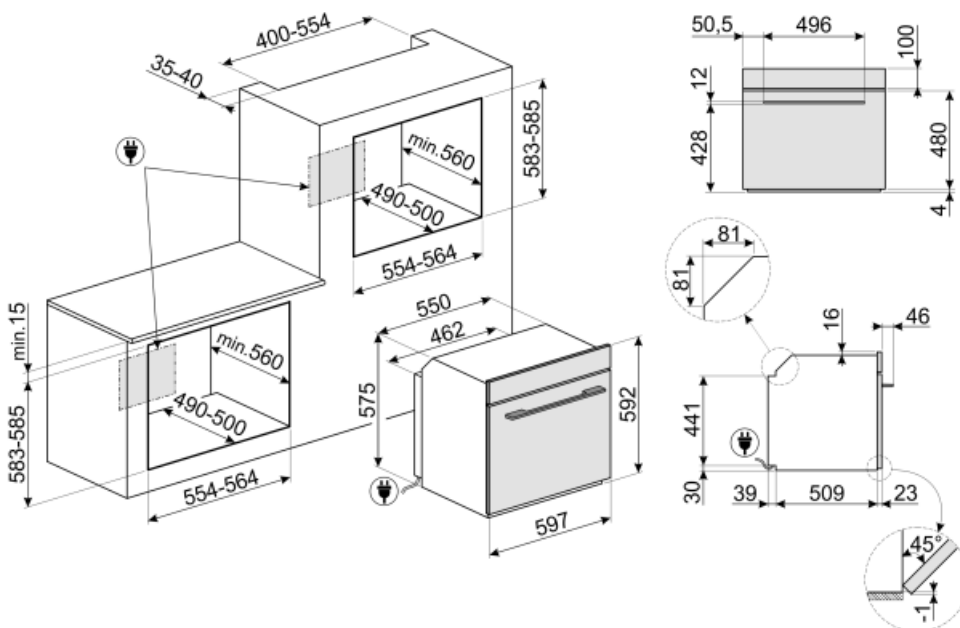

Accessoires niet inbegrepen

GTP

Gedeeltelijk uittrekbare telescopische geleiders (1 niveau)



PRTX



GT1P-2

Gedeeltelijk uittrekbare telescopische geleiders (1 niveau) voor ovens met metalen frame. Lengte: 355,5 mm, afzuiging: 285 mm. Materiaal: RVS AISI 430 gepolijst.



GTT

Volledig uittrekbare telescopische geleiders (1 niveau)



PR3845X

Antifingerprint roestvrij staal. Afdekstrip voor meubels in kolominstallatie van meer ovens



BN620-1

Geëmailleerde bakplaat, 20 mm diep



PALPZ

Pizzaschep met inklapbare handgreep breedte: 315 mm lengte: 325 mm

































BN640

Geëmailleerde bakplaat, 40 mm diep



Symbols glossary (TT)

 <p>A +: Energie-efficiëntieklasse A + helpt om tot 10% energie te besparen in vergelijking met klasse A. Maximale prestaties bij minimaal verbruik zijn gegarandeerd.</p>	 <p>Kinderslot: sommige modellen zijn voorzien van een apparaat om het programma / de cyclus te vergrendelen zodat het niet kan per ongeluk veranderd</p>
 <p>Luchtkoelsysteem: om een veilig oppervlak te garanderen temperaturen.</p>	 <p>Ontdooien op tijd: met deze functie wordt automatisch het tijdstip van ontdooien van voedsel bepaald</p>
 <p>Deuren met driedubbele beglazing: aantal glazen deuren.</p>	 <p>Electric</p>
 <p>Geëmailleerde binnenkant: De geëmailleerde binnenkant van alle Smeg-ovens heeft een speciale antacidumvoering die helpt om de binnenkant schoon te houden door de hoeveelheid kookvet te verminderen.</p>	 <p>Ventilator met bovenste en onderste elementen: de elementen in combinatie met de ventilator zijn bedoeld om een meer gelijkmatige warmte te bieden, een methode die vergelijkbaar is met conventioneel koken, dus voorverwarmen is vereist. Het meest geschikt voor items die langzaam koken vereisen.</p>
 <p>De ovenruimte wordt tegelijk door het onder- en bovenelement verwarmt. De hitteverdeling over het gerecht is afhankelijk van het niveau waarop men dit plaatst. Geschikt voor bakken op 1 niveau. Gerechten: alle ovenschotels, vlees, gevogelte, brood, (gevulde) taarten. Speciaal: gans en eend (bevatten veel vet).</p>	 <p>De ovenruimte wordt uitsluitend verhit door het onderelement. Voor gerechten die een hoge basistemperatuur behoeven, heeft deze bakstand weinig tot geen invloed op de korst aan de bovenzijde. Geschikt voor bakken op 1 niveau, ideaal voor deeggerechten die moeten rijzen (bijv. pizza). Bij gevulde taarten zal de deegbodem beter droog blijven.</p>
 <p>Circulaire with lower element: The addition of the lower element adds extra heat at the base for food which requires extra cooking.</p>	 <p>Circulaire: it is the perfect function for cooking all types of dishes in a more delicate way. The heat comes from the back of the oven and is distributed quickly and evenly The fan is active. It is also ideal for cooking on multiple levels without mixing smells and flavors.</p>
 <p>ECO: low energy consumption cooking: this function is particularly suitable for cooking on a single shelf with low energy consumption. It is recommended for all types of food except those that can generate a lot of moisture (for example vegetables). To achieve maximum energy savings and reduce time, it is recommended to put the food in the oven without preheating the cooking compartment</p>	 <p>De warmte wordt geproduceerd door het grill- en bovenelement. Verhitting over het volledige oppervlak. De thermostaat wordt, afhankelijk van het gerecht, in de regel op de maximale stand gezet. Bij een korte baktijd kan de oven deur gesloten blijven; bij langere baktijd blijft deze gedeeltelijk geopend. Voor vleesgerechten (klein- en middelgroot), vleespennen, vis, groenten, gratineren etc.</p>

- | | |
|--|---|
|  <p>Ventilator met grillelement: De ventilator vermindert de felle hitte van de grill en biedt een uitstekende methode om verschillende soorten voedsel, karbonades, steaks, worstjes enz. Te grillen, waardoor het gelijkmatig bruin wordt en de warmte wordt verdeeld, zonder het voedsel uit te drogen. De bovenste twee niveaus die voor gebruik worden aanbevolen, en het onderste deel van de oven kunnen worden gebruikt om gerechten tegelijkertijd warm te houden, een uitstekende mogelijkheid bij het bereiden van een gegrild ontbijt. Halve grill (alleen middengedeelte) is ideaal voor kleine hoeveelheden voedsel.</p> |  <p>Pizza function: Specific function for cooking pizza in a pan. It allows to obtain a pizza that is soft inside and crispy outside with the topping perfectly cooked, not dry and not burnt.</p> |
|  <p>Turbo: the heat comes from 3 directions: above, below and from the back of the oven The fan is active. It allows quick cooking, even on several shelves without mixing the aromas. Ideal for large volumes or foods that require intense cooking.</p> |  <p>All glass inner door: All glass inner door, a single flat surface which is simple to keep clean.</p> |
|  <p>The inner door glass: can be removed with a few quick movements for cleaning.</p> |  <p>KEEP_WARM_72dpi</p> |
|  <p>verlichting</p> |  <p>Air at 40°C provides the perfect environment for proving yeast type dough mixes. Simply select the function and place dough in the cavity for allotted</p> |
|  <p>Rapid preheating: cooking is preceded by the preheating phase which allows the cooking compartment to reach the set temperature. This option reduces the time by up to 50%.</p> |  <p>SABBATH: function that allows to cook food respecting Judaism's day of rest provisions.</p> |
|  <p>The oven cavity has 5 different cooking levels.</p> |  <p>Electronic control: Allows you to maintain temperature inside the oven with the precision 2-3 ° C. This enables to cook meals that are very sensitive to temperature changes, such as cakes, souffles, puddings.</p> |
|  <p>Tilting grill: the tilting grill can be easily unhooked to move the heating element and clean the roof of the appliance in one simple step.</p> |  <p>Vapor Clean: a simple cleaning function using steam to loosen deposits in the oven cavity.</p> |
|  <p>The capacity indicates the amount of usable space in the oven cavity in litres.</p> |  <p>With a simple and intuitive interface, the COMPACTscreen provides a pleasant user experience, thanks to the interaction with the knobs.</p> |