

SO4301M0N



Categorie	45 cm
Familie	Oven
Voeding	Elektrisch
Warmte bron	Elektrisch
Bereidingswijze	Magnetron met grill
Technologie	Micro + grill
EAN-code	8017709315542



Esthetiek

Esthetiek	Classici	Kleur serigrafie	Zilver
Kleur	Zwart	Type zeefdruk	Symbolen
Afwerking	Mat	Deur	Met 2 horizontale stroken
Design	Plat	Handgreep	Classici
Materiaal	RVS	Kleur handgreep	Zwart
Type roestvrijstaal	Geborsteld	Logo	In reliëf
Type glas	Zwart		

Bediening



Naam display	CompactScreen	Aantal bedieningsknoppen	2
Display technologie	LCD	Bedieningsknoppen	Classici
Regeling bediening	Bedieningsknoppen	Kleur knoppen	Zwart

Programma's / functies

Aantal kookfuncties	4
Traditionele kookfuncties	

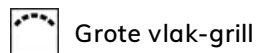

Microwave functions

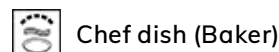

Overige functies

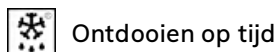

Opties



Opties
tijdprogrammering
Timer
Kinderbeveiliging

Automatische in- en
 uitschakeling
 Ja
 Ja

Overige opties
Showroom demo optie

Warmhoudfunctie
 Ja

Technische specificaties



Minimum temperatuur 50 °C
Maximum temperatuur 250 °C
Aantal kookniveaus 2
Type ovenrekken Metalen zijsteunen
Kantelbare grill Ja
Aantal lampen 1
Soort verlichting Halogeen
Vermogen lamp 40 W
Automatische inschakeling verlichting bij openen deur Ja
Grill - vermogen 1500 W
Automatische uitschakeling verhittingselementen bij openen deur Ja

Deur openen Standaard opening
Deur Temperatuur gecontroleerde deur
Totaal aantal ruiten 3
Automatische uitschakeling magnetron bij openen deur Ja
Veiligheidsthermostaat Ja
Koelsysteem Mantelkoeling
Koelleiding Enkel
Afmetingen bruikbare interne ovenruimte (hxbxd) 212x462x407 mm
Temperatuurregeling Elektronisch
Materiaal ovenruimte Ever Clean emaille
Veiligheidsscherm magnetrondeur Ja

Prestaties / energielabel



Netto inhoud 40 l
Aantal ovens 1

Effectief magnetronvermogen 800 W

Meegeleverde accessoires

Ovenrooster met stop 1

Elektrische aansluiting

Spanning 220-240 V

Frequentie 50 Hz

Stroom 13 A
 Nominale aansluitwaarde 3000 W

Lengte voedingskabel 115 cm

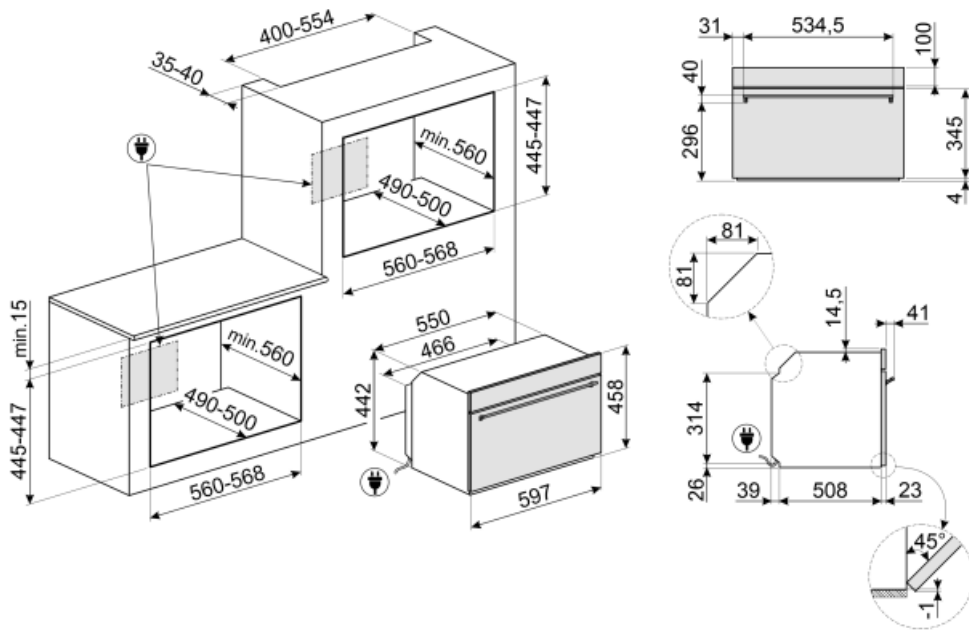

Accessoires niet inbegrepen

AIRFRY

Airfryerrek AIRFRY . Ideaal voor traditioneel frituren in de oven, maar met minder calorieën en minder vet. Hiermee creëer je snel en eenvoudig gerechten zoals frites, gebakken groenten en vis, waardoor ze perfect bruin en krokant worden.





















STONE

Rectangular refractory stone Ideal for cooking pizzas with the same results as a typical wood-fired oven. Can also be used for baking bread, focaccias and other recipes such as pies, flans or biscuits Dimensions:L42 x H1,8 x P37,5 cm.



Symbols glossary (TT)

 <p>Kinderslot: sommige modellen zijn voorzien van een apparaat om het programma / de cyclus te vergrendelen zodat het niet kan per ongeluk veranderd</p>	 <p>Microwave energy shortens cooking times dramatically and produces energy savings.</p>
 <p>Luchtkoelsysteem: om een veilig oppervlak te garanderen temperaturen.</p>	 <p>Ontdooien op tijd: met deze functie wordt automatisch het tijdstip van ontdooien van voedsel bepaald</p>
 <p>Deuren met driedubbele beglazing: aantal glazen deuren.</p>	 <p>Electric</p>
 <p>Geëmailleerde binnenkant: De geëmailleerde binnenkant van alle Smeg-ovens heeft een speciale antacidumvoering die helpt om de binnenkant schoon te houden door de hoeveelheid kookvet te verminderen.</p>	 <p>Crisper: The simultaneous operation of the microwave, grill and crisper plate (once pre-heated) allows the food to go crispy and golden, ideal for cooking Pizza etc</p>
 <p>De warmte wordt geproduceerd door het grill- en bovinelement. Verhitting over het volledige oppervlak. De thermostaat wordt, afhankelijk van het gerecht, in de regel op de maximale stand gezet. Bij een korte baktijd kan de oven gesloten blijven; bij langere baktijd blijft deze gedeeltelijk geopend. Voor vleesgerechten (klein- en middelgroot), vleespennen, vis, groenten, gratineren etc.</p>	 <p>Microwave: Penetrating straight into the food, microwaves cook very quickly and with considerable energy savings. Suitable for cooking without fat, they are also able to thaw and heat food without altering its original appearance and aroma. The microwave function can also be combined with conventional functions with all the resulting advantages. Ideal for all types of food.</p>
 <p>Microwave + grill element: The use of the grill results in a perfect browning of the surface of the food. The action of microwaves allows instead of cooking in a short time the internal part of the food.</p>	 <p>Compact appliances with a height of 45 cm - perfect solution to meet the functional requirements of kitchen sets of small height. Available in several types and in different styles.</p>
 <p>KEEP_WARM_72dpi</p>	 <p>verlichting</p>
 <p>The oven cavity has 2 different cooking levels.</p>	 <p>Electronic control: Allows you to maintain temperature inside the oven with the precision 2-3 ° C. This enables to cook meals that are very sensitive to temperature changes, such as cakes, souffles, puddings.</p>
 <p>Tilting grill: the tilting grill can be easily unhooked to move the heating element and clean the roof of the appliance in one simple step.</p>	 <p>The capacity indicates the amount of usable space in the oven cavity in litres.</p>
 <p>With a simple and intuitive interface, the COMPACTscreen provides a pleasant user experience, thanks to the interaction with the knobs.</p>	