

# FMI020X

Bruikbare inhoud

20 l



Familie

Magnetron

Categorie

Inbouw

Installatie

Met frame

Voeding

Elektrisch

Bereidingswijze

Magnetron met grill

Bediening

Elektro-mechanisch



## Programma's / functies

Aantal functies

5

Grote vlakgrill



Ontdooien op tijd



Ontdooien op gewicht



Magnetron



Magnetron + grill



Automatische programma's

8

Overige functies magnetron

Multi-session cooking

## Bediening

Display / Klok

1 LED

Bedieningsknoppen

Push-push

Type bediening

Bedieningsknoppen/ -  
toetsen

Kleur knoppen

Rvs look

Opening

Mechanical button

Kleur toetsen

Rvs look

Aantal

1

bedieningsknoppen

## Opties



Timer

Elektronisch

Kinderbeveiliging

Ja

Quick Start optie

Ja

---

<b>Opties tijdprogrammering</b>	Eind
<b>Akoestisch signaal einde kooktijd</b>	Ja

## Technische specificaties

---



<b>Materiaal ovenruimte</b>	RVS	<b>Deur openen</b>	Side-opening
<b>Aantal lampen</b>	1	<b>Totaal aantal ruiten</b>	1
<b>Soort verlichting</b>	Led	<b>Veiligheidsthermostaat</b>	Ja
<b>Draaiplateau</b>	Ja	<b>Koelsysteem</b>	Mantelkoeling
<b>Afmetingen draaiplateau</b>	24,5 cm	<b>Veiligheidsscherm magnetrondeur</b>	Ja
<b>Automatische inschakeling verlichting bij openen deur</b>	Ja	<b>Automatische uitschakeling magnetron bij openen deur</b>	Ja
<b>Type grill</b>	Verwarmingselement	<b>Afmetingen bruikbare interne ovenruimte (hxbxd)</b>	218x315x295 mm
<b>Grill - vermogen</b>	1000 W	<b>Effectief magnetronvermogen</b>	800 W

## Meegeleverde accessoires

---

<b>Ovenrooster</b>	1	<b>Kader</b>	Ja
--------------------	---	--------------	----

## Elektrische aansluiting

---



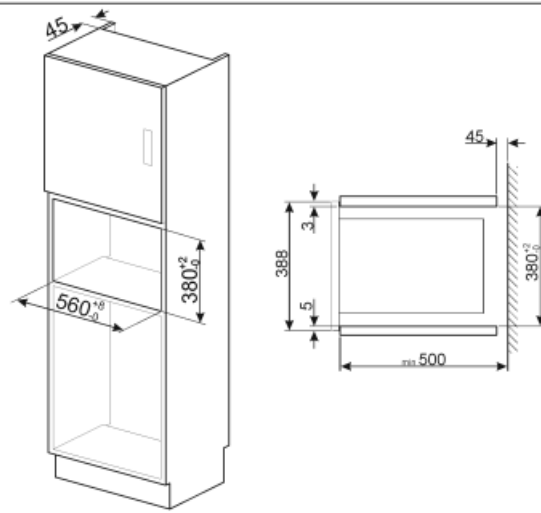
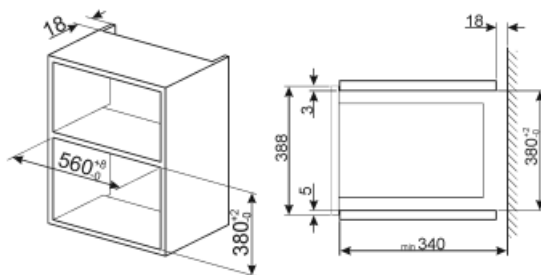
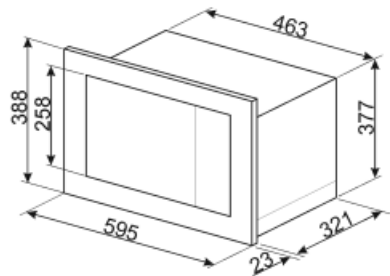





<b>Aansluitwaarde</b>	1250 W	<b>Frequentie (Hz)</b>	50 Hz
<b>Stroom</b>	5,4 A	<b>Lengte voedingskabel</b>	150 cm
<b>Spanning (V)</b>	230 V		



---

## Symbols glossary (TT)

---

- |  |   |   |  |
|--|---|---|--|
|    | Kinderslot: sommige modellen zijn voorzien van een apparaat om het programma / de cyclus te vergrendelen zodat het niet kan per ongeluk veranderd   |  | Microwave energy shortens cooking times dramatically and produces energy savings.  |
|    | Ontdooien op tijd: met deze functie wordt automatisch het tijdstip van ontdooien van voedsel bepaald  |  | Ontdooien op gewicht: Met deze functie wordt de ontdooitijd bepaald  |
|    | De warmte wordt geproduceerd door het grill- en bovenelement. Verhitting over het volledige oppervlak. De thermostaat wordt, afhankelijk van het gerecht, in de regel op de maximale stand gezet. Bij een korte baktijd kan de oven deur gesloten blijven; bij langere baktijd blijft deze gedeeltelijk geopend. Voor vleesgerechten (klein- en middelgroot), vleespennen, vis, groenten, gratineren etc. |  | Microwave: Penetrating straight into the food, microwaves cook very quickly and with considerable energy savings. Suitable for cooking without fat, they are also able to thaw and heat food without altering its original appearance and aroma. The microwave function can also be combined with conventional functions with all the resulting advantages. Ideal for all types of food. |
|    | Microwave + grill element: The use of the grill results in a perfect browning of the surface of the food. The action of microwaves allows instead of cooking in a short time the internal part of the food.   |  | verlichting  |
|  | The capacity indicates the amount of usable space in the oven cavity in litres.   |   |  |