

TR103IGR2

Categorie fornuis	100x60 cm
N. of cavities with energy label	2
Cavity heat source	Elektriciteit
Type kookplaat	Inductie
Type primaire oven	Thermogeventileerd
Type secundaire oven	Thermogeventileerd
Reinigingssysteem primaire oven	Vapor Clean reiniging
EAN-code	8017709312428
Energie-efficiëntieklasse	A
Energie-efficiëntieklasse, tweede oven	B



Design

Design	Victoria	Kleur toetsen	Zwart
Kleur	Leigrijs	Aantal bedieningsknoppen	9
Design	Victoria	Kleur serigrafie	Zwart
Deur	Met kader	Handgreep	Smeg Victoria
Upstand	Ja	Kleur handgreep	Geborsteld inox
Kleur kookplaat	Black enamel	Type glas	Zwart
Afwerking bedieningspaneel	Gekleurd plaatstaal	Plint	Antraciet
Bedieningsknoppen	Smeg Victoria	Logo	assembled 50's
Kleur bedieningsknoppen	Inox	Positie logo	Upstand+ Bedieningspaneel
Display	Elektronisch 5 toetsen		

Programma's / Functies

Aantal kookfuncties 5
Traditionele bereidingsfuncties



Statisch



Geventileerd



Circulatie (ventilator + circulaire)



ECO



Geventileerde onderwarmte

Reinigingsfuncties



Vapor Clean reiniging

Overige functies

 Ontdooien op tijd

Programma's / Functies secundaire oven

Aantal kookfuncties 1
Traditionele bereidingsfuncties, 2e oven



Circulatie (ventilator + circulaire)

Programma's / Functies derde oven

Aantal functies derde oven 1

Licht 

Grote vlakgrill 

Technische specificaties kookplaat

Totaal aantal kookzones 5

Linksvoor - Inductie - enkel - 1.30 kW - Booster 1.40 kW - - Ø 21.0 cm

Linksachter - Inductie - enkel - 2.30 kW - Booster 3.00 kW - - Ø 18.0 cm

Midden - Inductie - enkel - 2.30 kW - Booster 3.00 kW - - Ø 27.0 cm

Rechtsachter - Inductie - enkel - 1.30 kW - Booster 1.40 kW - - Ø 18.0 cm

Rechtsvoor - Inductie - enkel - 2.30 kW - Booster 3.00 kW - - Ø 21.0 cm

Technische specificaties primaire oven



Aantal lampen	1	Aantal ruiten ovendeur	3
Aantal ventilatoren	1	Aantal thermo-reflecterende ruiten	1
Netto volume 1e oven	61 l	Veiligheidsthermostaat	Ja
Bruto volume, oven 1	70 l	Koelsysteem	Mantelkoeling
Materiaal ovenruimte	Ever Clean emaille	Afmetingen bruikbare interne ovenruimte (hxbxd)	316x460x412 mm
Aantal kookniveaus	4	Temperatuurregeling	Elektro-mechanisch
Type ovenrekken	Metalen zijsteunen	Onderwarmte - vermogen	1200 W
Type licht	Halogeen	Bovenwarmte - vermogen	1000 W
Vermogen lamp	40 W	Grill - vermogen	1700 W
Opties bereidingstijdprogrammering	Begin en eind		
Opening deur	Side opening		
Side opening door	Ja		
Uitneembare ovendeur	Ja		
Volledig glazen binnendeur	Ja		

Grote vlakgrill - vermogen	2700 W
Circulatie - vermogen	2000 W
Grill type	Elektrisch
Kantelbare grill	Ja

Opties primaire oven

Timer	Ja	Minimum temperatuur	50 °C
Geluidssignaal einde kooktijd	Ja	Maximum temperatuur	250 °C

Technische specificaties secundaire oven



Aantal ventilatoren	2	Uitneembare ovendeur	Ja
Netto volume 2e oven	84 l	Volledig glazen binnendeur	Ja
Bruto volume, oven 2	94 l	Uitneembaar glas binnendeur	Ja
Materiaal ovenruimte	Ever Clean emaille	Aantal ruiten ovendeur	2
Aantal kookniveaus	9	Aantal thermo-reflecterende ruiten	1
Type ovenrekken	Metalen zijsteunen	Veiligheidsthermostaat	Ja
Aantal lampen	1	Koelsysteem	Mantelkoeling
Type lamp	Halogeen	Afmetingen bruikbare interne ovenruimte (hxbxd)	605x375x375 mm
Vermogen lamp	40 W	Temperatuurregeling	Elektro-mechanisch
Opening deur	Side opening	Circulatie - vermogen	2 x 1550 W
Side opening door	Ja		

Opties secundaire oven

Minimum temperatuur	50 °C	Maximum temperatuur	245 °C
---------------------	-------	---------------------	--------

Technische specificaties derde oven



Netto volume, 3e oven	36 l	Uitneembaar glas binnendeur	Ja
Bruto volume, oven 3	41 l	Aantal ruiten ovendeur	3
Materiaal ovenruimte	Ever Clean emaille	Aantal thermo-reflecterende ruiten	1
Aantal kookniveaus	2	Veiligheidsthermostaat	Ja
Type ovenrekken	Metalen zijsteunen	Koelsysteem	Mantelkoeling
Aantal lampen	1	Afmetingen bruikbare interne ovenruimte (hxbxd)	169x440x443 mm
Type lamp	Halogeen	Temperatuurregeling	Elektro-mechanisch
Vermogen lamp	40 W		
Opening deur	Neerwaarts		
Uitneembare ovendeur	Ja		

Volledig glazen binnendeur	Ja	Grote vlakgrill - vermogen	2700 W
		Type grill	Elektrisch
		Kantelbare grill	Ja

Opties derde oven

Minimum temperatuur	50 °C	Maximum temperatuur	260 °C
----------------------------	-------	----------------------------	--------

Meegeleverde accessoires primaire oven en kookplaat



Ovenrooster met stop	2	Inzetrooster	1
Bakplaat (40 mm)	1	Telescopische geleiders, gedeeltelijk uitschuifbaar	1

Meegeleverde accessoires secundaire oven



Ovenrooster met stop	4	Bordenwarmhouder	1
-----------------------------	---	-------------------------	---

Meegeleverde accessoires derde oven

Ovenrooster met stop	1	Bakplaat (40 mm)	1
-----------------------------	---	-------------------------	---

Elektrische aansluiting

Nominale aansluitwaarde	15400 W	Frequentie	50/60 Hz
Stroom	43 A	Lengte voedingskabel	150 cm
Spanning	220-240 V	Connection box	5 polig
Spanning 2 (V)	380-415 V		

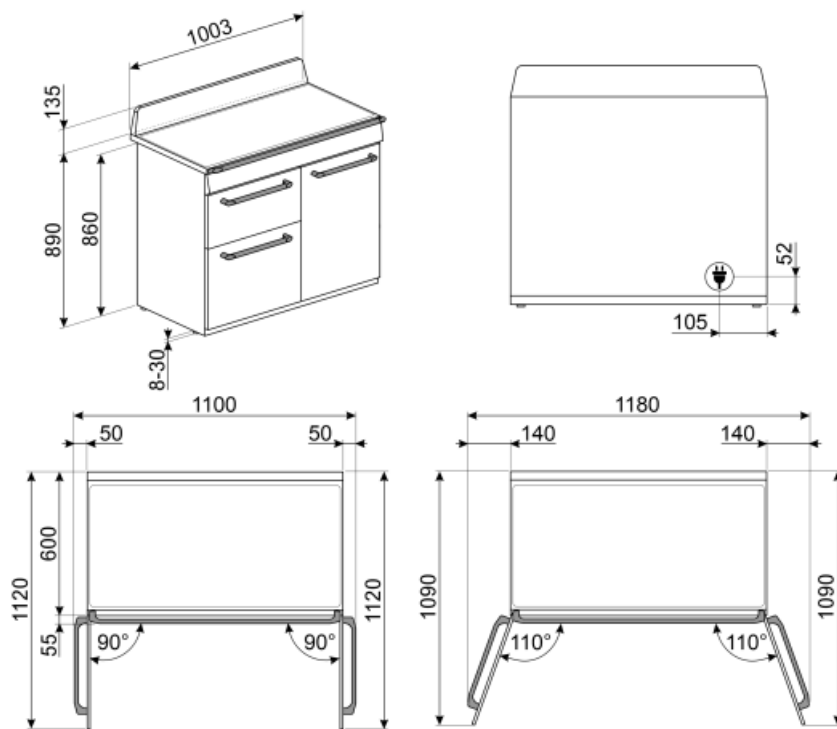

Not included accessories

AIRFRY



GTP

Partially extractable telescopic guides (1 level), suitable for traditional ovens. Made in stainless steel, they guarantee stability and facilitate the smooth extraction of the trays.



BNP608T

Teflon bakplaat, 8mm diep



KIT1TR103

Splashback black, 100cm, suitable for TR103 Victoria cookers



KITH103

Height extension kit (950 mm), black, suitable for TR103 cookers (945-960mm)



BBQ

Dubbelzijdig



PALPZ

Pizzapallet inox met plooibaar handvat, 315x325 mm



BN640

Enamelled tray suitable for 45cm and 60cm ovens. Depth 540 mm. Perfect for cooking and roasting meat and fish in sauces. Also ideal for experimenting with lighter and crunchy side dishes



SFLK1

Child lock



PRTX

Ronde pizzasteen met handvaten, diameter 35 cm



GRILLPLATE

Universal griddle for induction, gas, ceramic and electric hobs. Non-stick surface ideal for cooking meat, cheese and vegetables. Dimensions: 410 x 240 mm.



BN620-1

Enamelled tray suitable for 45cm and 60cm ovens. Depth 20 mm. Perfect for a wide range of savoury and sweet baking.



SCRP

Schraper voor inductie- en vitrokeramische kookplaten



TPKPLATE

Universal plate for induction, gas, ceramic and electric hobs. Non-stick surface ideal for cooking fish, eggs and vegetables. Dimensions: 410 X 240 mm.



GTT

Volledig uitschuifbare telescopische rails (1 niveau) voor traditionele ovens (SF-).







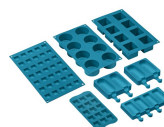























SMOLD

Set van 7 siliconen vormen voor ijsjes, pralines, ijsblokjes of porties. -60°C tot 230°C.



Symbols glossary (TT)

 <p>A: Product drying performance, measured from A+++ to D / G depending on the product family</p>	 <p>B: Product energy rating, measured from A+++ to D / G depending on the product family.</p>
 <p>Sommige modellen zijn voorzien van een functie om het programma/de cyclus te blokkeren zodat het niet per ongeluk kan aangepast worden.</p>	 <p>Air cooling system: to ensure a safe surface temperatures.</p>
 <p>Defrost by time: Manual defrost function. At the end of the set duration, the function stops.</p>	 <p>Double glazed doors: Number of glazed doors.</p>
 <p>Triple glazed doors: Number of glazed doors.</p>	 <p>ECO-logic: option allows you to restrict the power limit of the appliance real energy saving.</p>
 <p>Ever Clean Enamel: Ever Clean enamel is applied electrostatically, corner to corner and edge to edge to prevent cracking or cracks over time. It is a particular pyrolytic enamel, resistant to acids which, in addition to being pleasantly bright, promotes greater cleaning of the oven walls, thanks to its lower porosity. It is baked at over 850 ° C and slowly polymerized at a scientifically determined rate to ensure uniform depth and strength Ever Clean enamel creates an impeccable finish both on the inside of the oven and on the trays, making the surfaces of the oven incredibly easy to maintain over time as it reduces the adhesion of fat during cooking</p>	 <p>Circogas: In gasovens verdeelt de ventilator de warmte snel en gelijkmatig over de ovenruimte, waardoor smaakoverdracht wordt vermeden bij het tegelijkertijd bereiden van een aantal verschillende gerechten. In elektrische ovens voltooit deze combinatie het koken van voedsel dat aan de oppervlakte klaar is, maar dat van binnen meer moet worden gekookt, zonder verder bruin te worden.</p>
 <p>Ventilator met bovenste en onderste elementen: De elementen in combinatie met de ventilator zijn bedoeld om een meer gelijkmatige warmte te bieden, een methode die vergelijkbaar is met conventioneel koken, dus voorverwarmen is vereist. Het meest geschikt voor items die langzaam koken vereisen.</p>	 <p>Alleen boven- en onder element: een traditionele kookmethode die het meest geschikt is voor losse items in het midden van de oven. de bovenkant van de oven zal altijd het heetst zijn. Ideaal voor gebraden vlees, fruitcake, brood etc.</p>
 <p>Circulaire: De combinatie van de ventilator en het ronde element eromheen zorgt voor een hete lucht kookmethode. Dit biedt vele voordelen, waaronder geen voorverwarmen als de kooktijd meer dan 20 minuten bedraagt, geen smaakoverdracht bij het gelijktijdig bereiden van verschillende soorten voedsel, minder energie en kortere kooktijden. Geschikt voor alle soorten voedsel.</p>	 <p>De combinatie van de grill, de ventilator en onderwarmte is interessant voor het bereiden van kleine hoeveelheden.</p>
 <p>Grill element: Using of grill gives excellent results when cooking meat of medium and small portions, especially when combined with a rotisserie (where possible). Also ideal for cooking sausages and bacon.</p>	 <p>Light</p>
 <p>Induction: The work of these hobs is based on the principle of electromagnetic induction. The heat is generated directly in the bottom of the pan during its contact with the hob.</p>	 <p>All glass inner door: All glass inner door, a single flat surface which is simple to keep clean.</p>

-
- | | | | |
|--|--|---|---|
|  | Side lights: Two opposing side lights increase visibility inside the oven. |  | Plate rack warming: function for heating or keeping dishes warm. Place the baking tray on the lowest shelf and stack the dishes to be heated. |
|  | The oven cavity has 2 different cooking levels. |  | The oven cavity has 4 different cooking levels. |
|  | The oven cavity has 9 different cooking levels. |  | Telescopic rails: allow you to pull out the dish and check it without having to remove it from the oven entirely. |
|  | Electronic control: Allows you to maintain temperature inside the oven with the precision 2-3 ° C. This enables to cook meals that are very sensitive to temperature changes, such as cakes, souffles, puddings. |  | Tilting grill: the tilting grill can be easily unhooked to move the heating element and clean the roof of the appliance in one simple step. |
|  | Vapor Clean: a simple cleaning function using steam to loosen deposits in the oven cavity. |  | The capacity indicates the amount of usable space in the oven cavity in litres. |
|  | The capacity indicates the amount of usable space in the oven cavity in litres. |  | The capacity indicates the amount of usable space in the oven cavity in litres. |