

SF4400MCX1

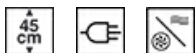

Categorie	45 cm
Familie	Oven
Voeding	Elektrisch
Warmte bron	Elektrisch
Bereidingswijze	Combi-magnetron
EAN-code	8017709315719



Esthetiek

Esthetiek	Selezione	Kleur serigrafie	Zwart
Kleur	RVS	Type zeefdruk	Symbolen
Afwerking	Vingervlekvrij	Deur	Met paneel
Design	Plat	Handgreep	Nuova Selezione
Materiaal	RVS	Kleur handgreep	Rvs look
Type roestvrijstaal	Geborsteld	Logo	In reliëf
Type glas	Zwart		

Bediening



Naam display	DigiScreen	Regeling bediening	Touch bottoms
Display technologie	Led		

Programma's / functies

Aantal kookfuncties 6
Traditionele kookfuncties



Circulaire

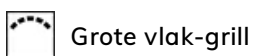

Grote vlak-grill

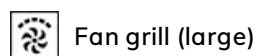

Fan grill (large)



Circulaire + bottom

Microwave functions



Magnetron



Circulaire



Microwave + grill

Microwaves + Circulaire + bottom

Opties



Opties tijdprogrammering	Einde kooktijd	Snelle voorverwarming	Ja
Timer	Ja		

Technische specificaties



Minimum temperatuur	50 °C	Automatische uitschakeling	Ja
Maximum temperatuur	200 °C	verhittingselementen bij	
Aantal kookniveaus	3	openen deur	
Type ovenrekken	Metalen zijsteunen	Deur openen	Standaard opening
Aantal lampen	1	Deur	Temperatuur gecontroleerde deur
Soort verlichting	Gloeilamp	Totaal aantal ruiten	3
Vermogen lamp	20 W	Automatische uitschakeling magnetron	Ja
Automatische inschakeling verlichting bij openen deur	Ja	bij openen deur	
Draaiplateau	Ja	Veiligheidsthermostaat	Ja
Diameter draaiplateau	36 cm	Koelsysteem	Mantelkoeling
Grill - vermogen	1750 W	Afmetingen bruikbare interne ovenruimte (hxbxd)	210x420x390 mm
Circulatie - vermogen	1600 W	Temperatuurregeling	Elektro-mechanisch
		Materiaal ovenruimte	RVS
		Veiligheidsscherm magnetrondeur	Ja

Prestaties / energielabel

Netto inhoud	44 l	Effectief magnetronvermogen	900 W
--------------	------	-----------------------------	-------

Elektrische aansluiting

Spanning	230 V	Frequentie	50 Hz
Stroom	15 A	Lengte voedingskabel	150 cm

Nominale
aansluitwaarde

3350 W

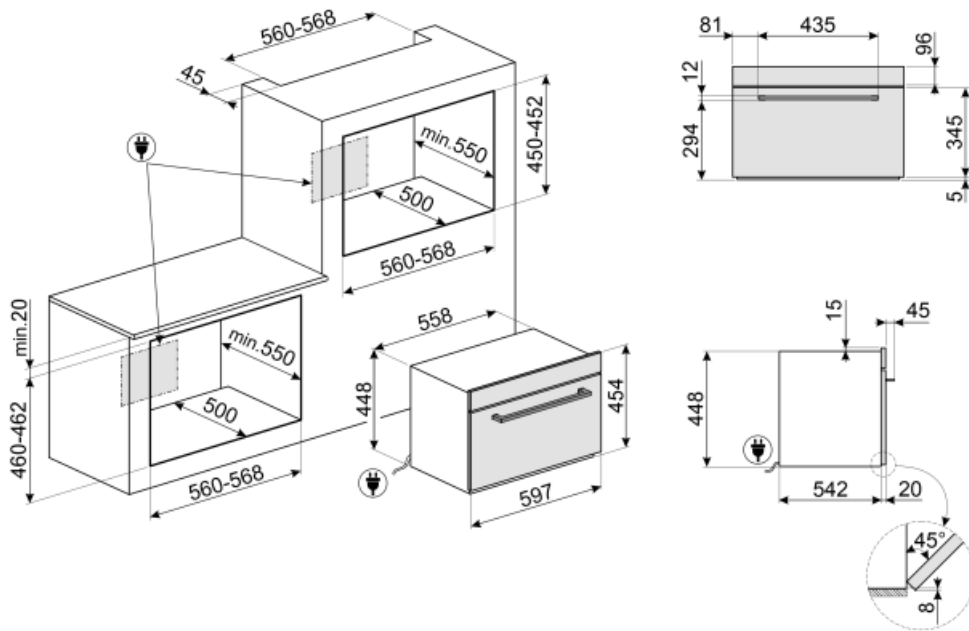

Accessoires niet inbegrepen

GTP

Gedeeltelijk uittrekbare telescopische geleiders (1 niveau)



GTT

Volledig uittrekbare telescopische geleiders (1 niveau)

















GT1P-2

Gedeeltelijk uittrekbare telescopische geleiders (1 niveau) voor ovens met metalen frame. Lengte: 355,5 mm, afzuiging: 285 mm. Materiaal: RVS AISI 430 gepolijst.



Symbols glossary (TT)

 <p>Combination microwave: This oven allows to combine two different ways of cooking (Traditional with microwaves). Combined ovens increase cooking opportunities, while providing maximum flexibility of household appliances.</p>	 <p>Luchtkoelsysteem: om een veilig oppervlak te garanderen temperaturen.</p>
 <p>Deuren met driedubbele beglazing: aantal glazen deuren.</p>	 <p>Electric</p>
 <p>Circulaire with lower element: The addition of the lower element adds extra heat at the base for food which requires extra cooking.</p>	 <p>Circulaire: it is the perfect function for cooking all types of dishes in a more delicate way. The heat comes from the back of the oven and is distributed quickly and evenly. The fan is active. It is also ideal for cooking on multiple levels without mixing smells and flavors.</p>
 <p>De warmte wordt geproduceerd door het grill- en bovenelement. Verhitting over het volledige oppervlak. De thermostaat wordt, afhankelijk van het gerecht, in de regel op de maximale stand gezet. Bij een korte baktijd kan de oven gesloten blijven; bij langere baktijd blijft deze gedeeltelijk geopend. Voor vleesgerechten (klein- en middelgroot), vleespennen, vis, groenten, gratineren etc.</p>	 <p>Ventilator met grillelement: De ventilator vermindert de felle hitte van de grill en biedt een uitstekende methode om verschillende soorten voedsel, karbonades, steaks, worstjes enz. Te grillen, waardoor het gelijkmatig bruin wordt en de warmte wordt verdeeld, zonder het voedsel uit te drogen. De bovenste twee niveaus die voor gebruik worden aanbevolen, en het onderste deel van de oven kunnen worden gebruikt om gerechten tegelijkertijd warm te houden, een uitstekende mogelijkheid bij het bereiden van een gegrild ontbijt. Halve grill (alleen middengedeelte) is ideaal voor kleine hoeveelheden voedsel.</p>
 <p>Microwave: Penetrating straight into the food, microwaves cook very quickly and with considerable energy savings. Suitable for cooking without fat, they are also able to thaw and heat food without altering its original appearance and aroma. The microwave function can also be combined with conventional functions with all the resulting advantages. Ideal for all types of food.</p>	 <p>Cooking with the simultaneous use of the heating element in combination with fan and microwave supply.</p>
 <p>Microwave + grill element: The use of the grill results in a perfect browning of the surface of the food. The action of microwaves allows instead of cooking in a short time the internal part of the food.</p>	 <p>Compact appliances with a height of 45 cm - perfect solution to meet the functional requirements of kitchen sets of small height. Available in several types and in different styles.</p>
 <p>Rapid preheating: cooking is preceded by the preheating phase which allows the cooking compartment to reach the set temperature. This option reduces the time by up to 50%.</p>	 <p>The oven cavity has 3 different cooking levels.</p>
 <p>4.3 inch display with LED technology, usability with knobs + 3 touch keys</p>	