

∅ 2mm

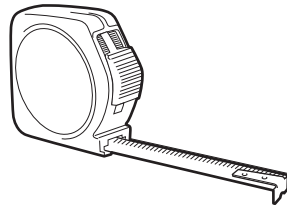

---

A



1x

B

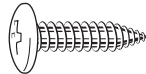

X 2

C



X 2

C



X 2

1

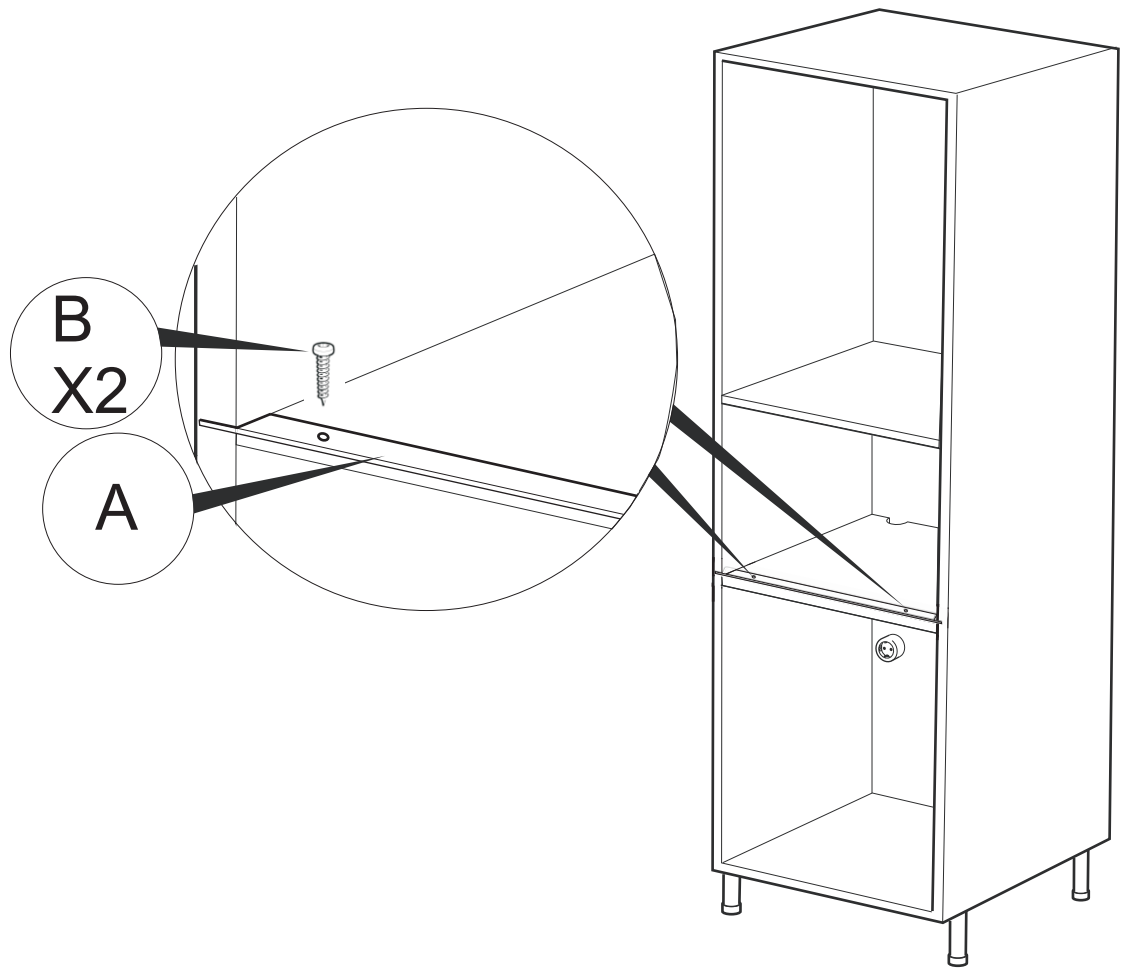

2

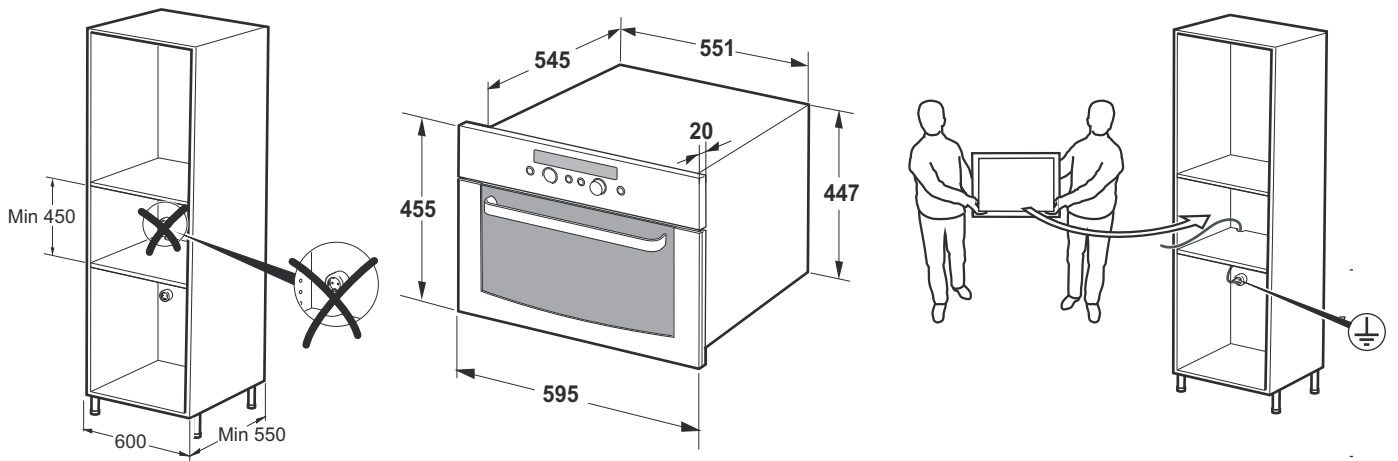

3

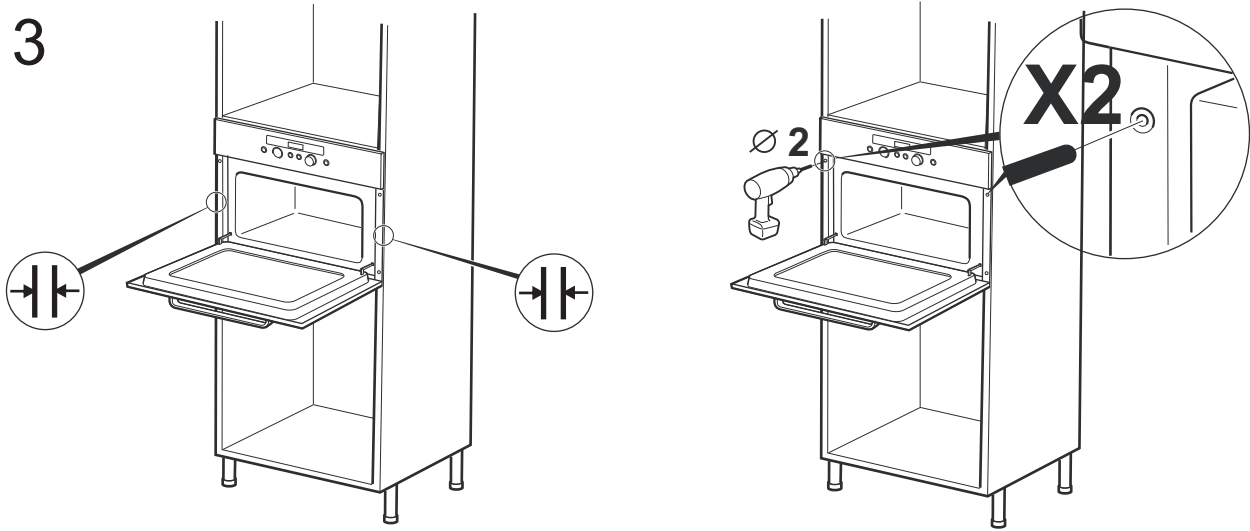

4

